

IC-4A/AT

440MHz FM TRANSCEIVER

INSTRUCTION MANUAL

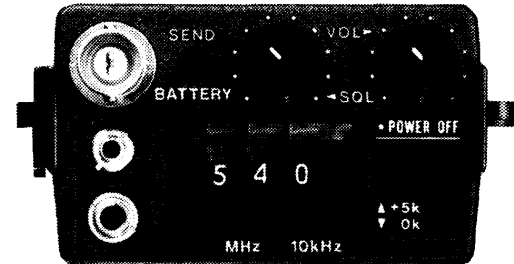

TABLE OF CONTENTS

I. INTRODUCTION.....	1
II. SPECIFICATIONS	2
III. ACCESSORIES.....	4
IV. PRE-OPERATION	5
V. CONTROL FUNCTIONS.....	10
VI. OPERATION	16
VII. INSIDE VIEW	18
VIII. CIRCUIT DESCRIPTION	20
IX. TROUBLE-SHOOTING	28
X. VOLTAGE CHARTS.....	31
XI. BLOCK DIAGRAM.....	35
XII. OPTIONS	36
XIII. P.C. BOARD LAYOUT.....	SEPARATE
XIV. SCHEMATIC DIAGRAM.....	SEPARATE

SECTION I INTRODUCTION

SYNTHESIZED HAND HELD TRANSCEIVER

This small, light weight 2000 channel transceiver comes in handy for use any time, whether outdoors, in a car, or at home, 2000 channels can be used on any 440MHz band frequency or any repeater.

DUAL POWER LEVEL

Transmitter output can be switched easily to either of two levels; 1.5W output HIGH for long distances, and 0.15W LOW for short distances. Battery consumption is minimized in the Low Power Mode. The IC-BP5 Power Pack as an option gives 2.3W output.

VARIOUS POWER PACKS AVAILABLE

The Power Pack is slipped on the bottom of the radio very easily, and various power packs are available to suit your needs, for minimum size, longer use, or higher power.

HIGHLY EFFICIENT FLEXIBLE ANTENNA

A highly efficient flexible antenna is supplied with the set. When the antenna is removed, its connector can be used for an external antenna connector.

16 KEY DUAL-TONE PAD (IC-4AT only)

The IC-4AT has a 16 key dual-tone encoder pad on the front panel. The pad can be used for auto-patch, accessing to closed repeater, and/or other controls.

SECTION II SPECIFICATIONS

GENERAL

Number of Semiconductors	Transistors	46
	FET	2
	IC	5 (IC-4AT: 6)
	Diodes	24
Frequency Coverage	440.000 ~ 449.995MHz	
Frequency Resolution	5KHz steps 2000 channels	
Frequency Control	Digital PLL synthesizer, with thumbwheel switches	
Frequency Stability	Within ± 2.5 KHz	
Usable Temperature	$-10^{\circ}\text{C} \sim 60^{\circ}\text{C}$ ($14^{\circ}\text{F} \sim 140^{\circ}\text{F}$)	
Antenna Impedance	50 ohms unbalanced	
Power Supply Requirement	DC 8.4V; with attendant power pack IC-BP3, DC 6 ~ 12V negative ground is acceptable	
Current Drain at 8.4V	Transmitting	
	HIGH : 1.5W	Approx. 700mA
	LOW : 0.15W	Approx. 300mA
	Receiving	
	At max audio output	Approx. 170mA
	Squelched	Approx. 22mA
Dimensions	116.5mm(H) x 65mm(W) x 35mm(D) Without power pack Attendant power pack, IC-BP3: 49mm(H) x 65mm(W) x 35mm(D)	
Weight	470g (IC-4AT : 490g) including power pack, IC-BP3 and flexible antenna	

TRANSMITTER

Output Power	HIGH: 1.5W, LOW: 0.15W at 8.4V
Emission Mode	16F ₃
Modulation System	Variable reactance frequency modulation
Max. Frequency Deviation	±5KHz
Spurious Emission	More than 60dB below carrier
Microphone	Built-in Electret condenser microphone Optional Speaker-microphone (IC-HM9) can be used
Operating Mode	Simplex Duplex: ±5.0MHz from receiveing frequency

RECEIVER

Receiving System	Double-conversion superheterodyne
Modulation Acceptance	16F ₃
Intermediate Frequency	1st: 21.8MHz 2nd: 455KHz
Sensitivity	More than 26dB S+N+D/N+D at 1μV Less than 0.5μV for 20dB Noise quieting
Squelch Sensitivity	Less than 0.4μV
Spurious response rejection ratio	More than 60dB
Selectivity	More than ±7.5KHz at -6dB point Less than ±15KHz at -60dB point
Audio Output Power	More than 400mW
Audio Output Impedance	8 ohms

Specifications are approximate and are subject to change without notice or obligation.

SECTION III ACCESSORIES

Carefully remove your transceiver from the packing carton and examine it for signs of shipping damage. Should any be apparent, notify the delivering carrier or dealer immediately, stating the full extent of the damage. It is recommended you keep the shipping cartons. In the event storage, moving, or reshipment becomes necessary, they come in handy. Various accessories are packed with the transceiver. Make sure you have not overlooked anything.

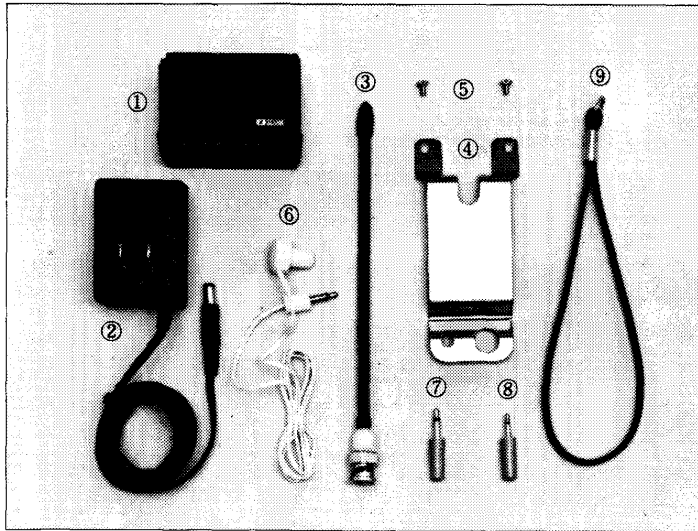

1. Power pack IC-BP3 1
2. Wall charger BC-25U 1
3. Flexible antenna 1
4. Belt clip. 1
5. Belt clip retaining screws. 2
6. Earphone. 1
7. Earphone plug 1
8. Microphone plug. 1
9. Hand-strap. 1

SECTION IV PRE-OPERATION

BATTERY INSTALLATION

When using Nickel-Cadmium power pack IC-BP3:

The IC-BP3 is a rechargeable Nickel-Cadmium power pack, and it can be slipped onto or off the set very easily. It has a connector for a charger charge-current control circuit, reverse polarity protection circuit and charge indicator LED in its own pack. You can use the supplied BC-25U wall charger or similar simple wall charger, or a car battery by using optional cable IC-CP1 for recharging. Before use, the power pack should be charged about 15 hours, because the battery may have discharged.

After charging is completed, the batteries can be used in the same manner as dry cells. However, the voltage of Nickel-Cadmium batteries drops rapidly just before they are exhausted, so when the Transmit Indicator LED of the transceiver goes out, be sure to immediately stop using it, and recharge the batteries again.

HOW TO CHARGE (When using Nickel-Cadmium power pack IC-BP3)

1. Use the supplied wall charger BC-25U or a stable power source with an output voltage of DC 13.8V and current capacity over 50mA, or use a 12V car battery with optional charger cable IC-CP1. (Output voltage of 12 ~ 15V can be used, but output voltage near the specified voltage should be used.)
2. The power switch of the transceiver must be OFF, or remove the power pack from the transceiver.

3. Connect the output plug of the wall charger (BC-25U), or other power source, to the charger socket of the power pack. (When charging Nickel-Cadmium batteries in the IC-BP4 power pack, you should use the BC-30 charger only.)

The charge indicator LED of the power pack is lit, which shows that the charger is working.

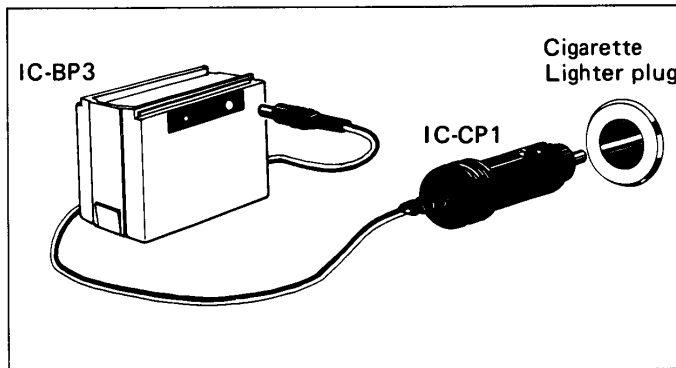
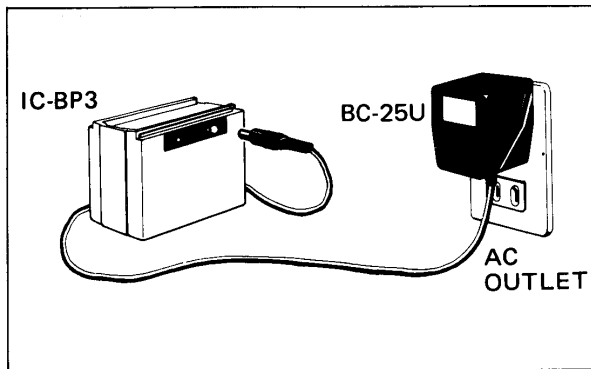

4. It takes about 15 hours to charge the batteries completely. This charger is designed for 0.1C (10-hour rate current), but charge for 15 hours in order to compensate for any unbalance of the batteries.

You should charge the batteries for 15 hours when you have not used them for a long time or after buying them.

5. Charge between 0°C and 40°C.
6. Avoid continuing charging as much as possible after full charging, (15 hours). If excess charging is repeated, efficiency of the power pack is reduced.
7. After charging, unplug the power source from the charger socket of the power pack. The transceiver and the power pack are now ready for operation.

When using the alkaline power pack IC-BP4:

Place the power switch in the OFF position. Remove the power pack from the bottom of the set by pushing the pack in the indicated direction. Separate the pack into two parts (cases) as follows:

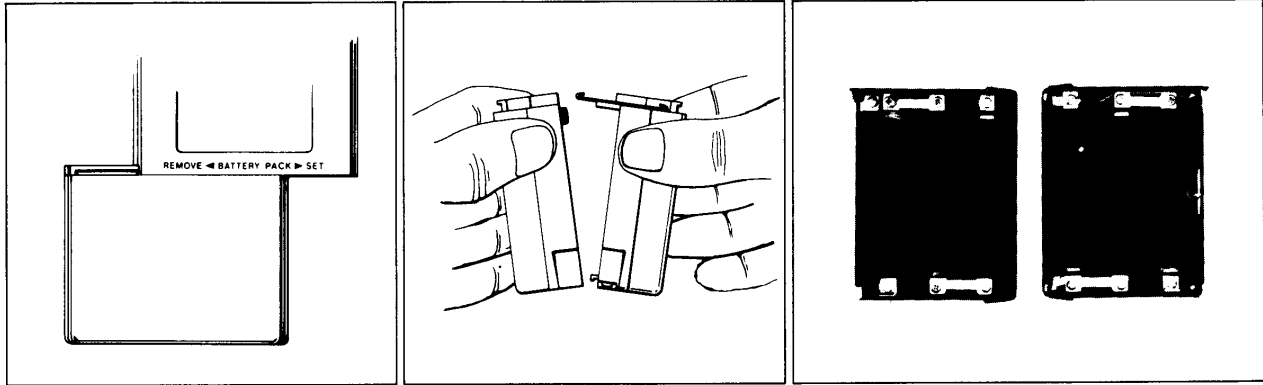

Each case holds three AA type batteries. Install batteries into each case, according to indicated polarity. With the batteries properly in place, carefully replace the pack and slip it onto the set with the reverse procedure.

Also, AA type Nickel-Cadmium, rechargeable, batteries can be used. But the charger for them should be the optional BC-30 charger.

WHEN TO REPLACE BATTERIES (When using alkaline batteries)

When the Transmit Indicator LED does not light up during transmission, the batteries are exhausted. Use batteries of the same type, for mixed types might cause leakage. Replace worn batteries with a complete new set. If used with old batteries, the life of new ones might be shortened. Battery life is

shortened more by transmitting than by receiving, since several times more current is drawn during transmission. To prolong battery life, therefore, practice the following:

- * Try to minimize the transmit period.
- * Reduce volume during reception.
- * Be sure to cut off power source when set is not used.

More working hours are available if high-performance batteries are employed.

FOR OUTDOOR USE

1. Attach the supplied power pack. (Refer to "BATTERY INSTALLATION")
2. Attach the supplied hand strap and belt clip through the fixture on the body (as shown in the drawings on page 9).
3. Attach the flexible rubber antenna.

FOR USE IN THE CAR

1. Avoid using the unit near the outlet of heaters, air-conditioners, etc.
2. Put the unit in a convenient place to avoid disrupting safe driving.
3. Firmly ground to the car body a mobile antenna (e.g. whip antenna).

FOR FIXED USE

1. Avoid putting the unit in places exposed to rain, water splash, direct sunshine, dust, vibration, or heat.
2. An external antenna should be used for indoor operation. The use of the flexible antenna indoors may cause TVI, BCI, Hi-Fi interference or a malfunction stabilized DC power supply.

EXTERNAL ANTENNA

1. Select a high performance antenna (a multi-element beam or gain antenna) and set it up in the highest possible position.
2. Use a 50 ohm antenna and coaxial cable.
3. On UHF, the power loss in the antenna cable is large, so use a cable with the lowest possible loss and make it as short as possible.
4. Use a BNC plug for connection to the unit.

ATTACHMENT OF HAND STRAP AND BELT CLIP

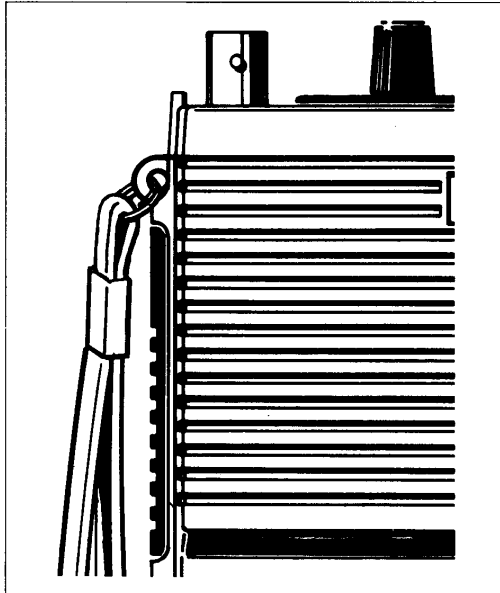

- Attach the belt clip on the back cover with the 2 screws supplied.

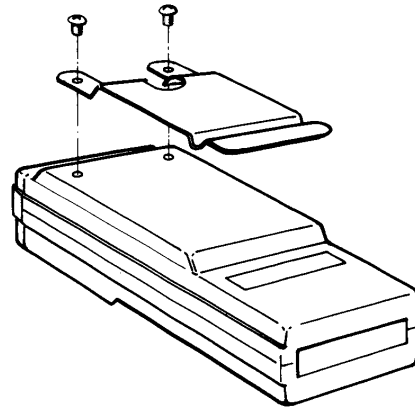

SECTION V CONTROL FUNCTIONS

TOP PANEL

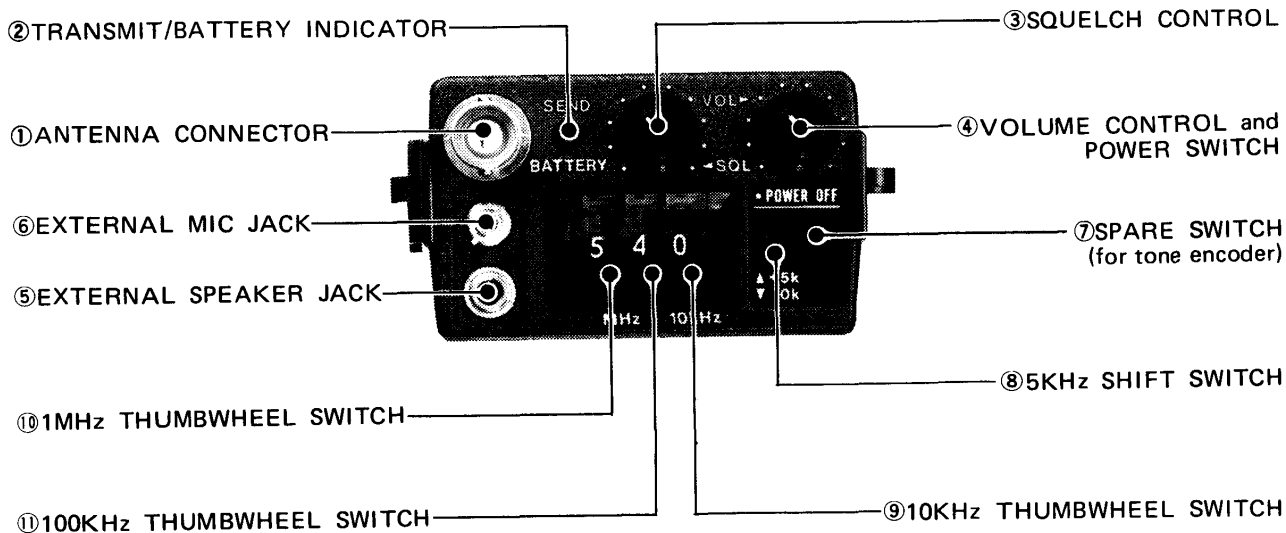

FRONT PANEL

REAR PANEL

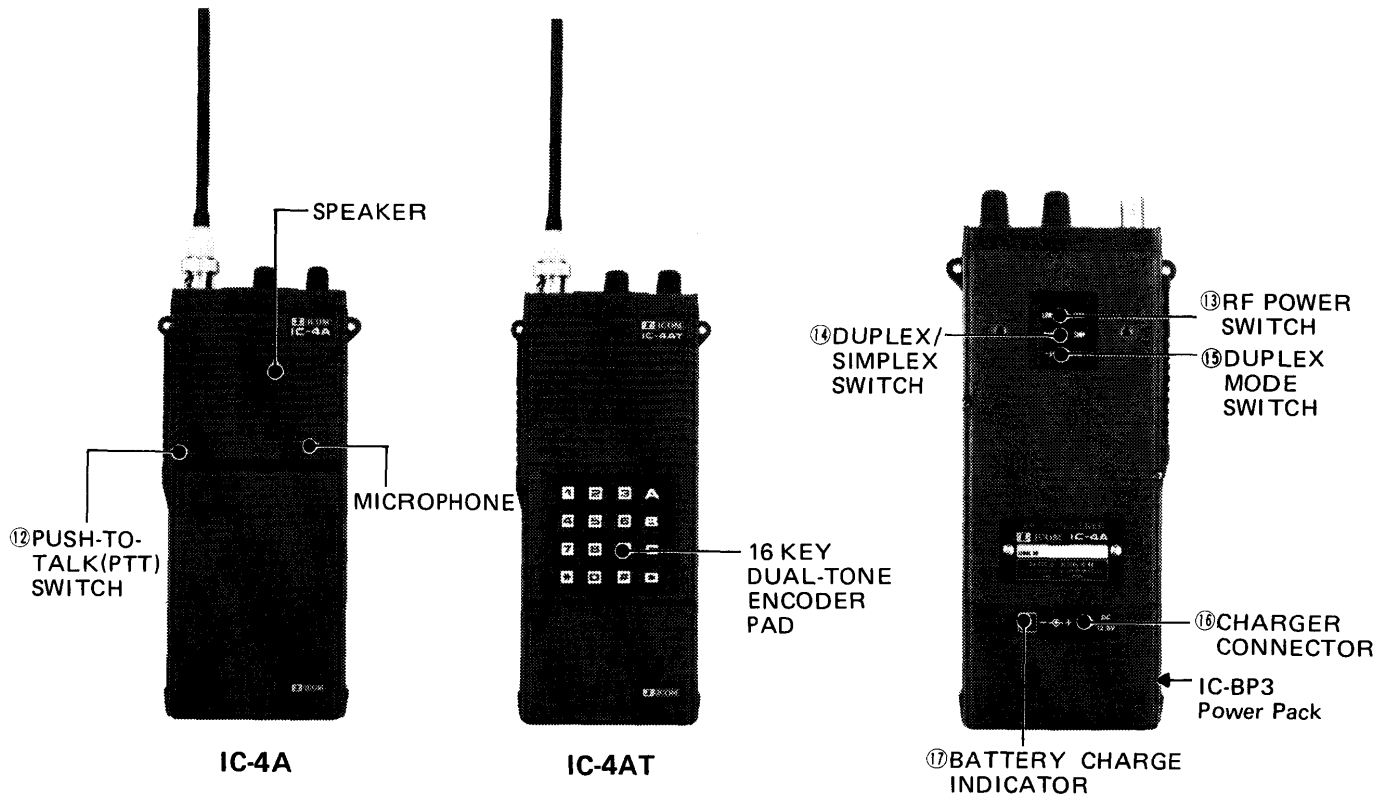

① **ANTENNA CONNECTOR**

Connect the supplied flexible antenna. An external antenna can be used, using a BNC connector.

② **TRANSMIT/BATTERY INDICATOR**

Illuminates in the transmit mode. Also indicates the battery condition; during transmission. The voltage of Nickel-Cadmium batteries drops rapidly just before they are exhausted, so when this indicator goes out, be sure to immediately stop using it, and charge the batteries again.

③ **SQUELCH CONTROL**

Sets the squelch threshold level. To turn OFF the squelch function, rotate this control completely counterclockwise. To set the threshold level higher, rotate the control clockwise.

④ **VOLUME CONTROL and POWER SWITCH**

When the control is turned completely counterclockwise, the power is OFF. By turning the control clockwise beyond the "click", the unit is turned ON and the audio level increases by further rotating it clockwise.

⑤ **EXTERNAL SPEAKER JACK**

When an external speaker (or an earphone) is used, connect it to this jack. Use a speaker with an impedance of 8 ohms. When the external speaker is connected the built-in speaker does not function.

⑥ **EXTERNAL MIC JACK**

When an external microphone is used, connect it to this jack. See the schematic for the proper hookup. When the external microphone is connected, the built-in microphone does not function. The IC-HM9 optional speaker-microphone can also be used.

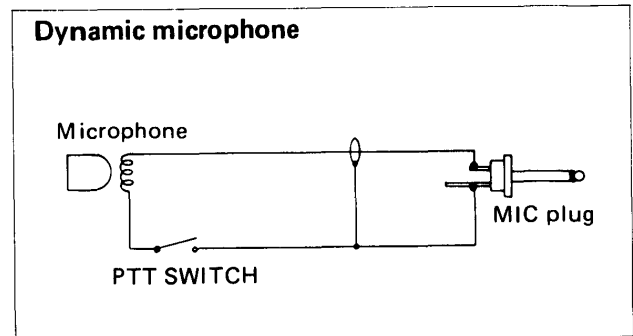
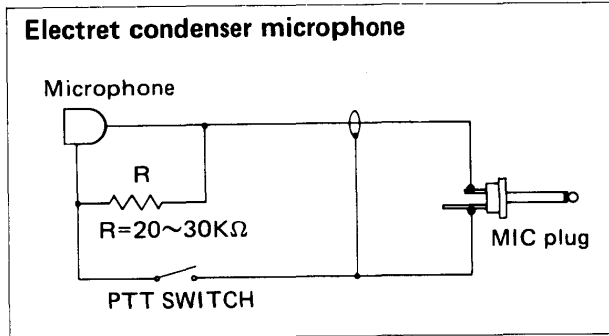

⑦ **SPARE SWITCH**

This is a spare switch, and can be adapted to your needs such as a sub-audio tone encoder switch.

⑧ **5KHz SHIFT SWITCH**

When the desired operating frequency has a 5KHz digit, set this switch in the +5KHz position, and add 5KHz to the indicated frequency on the thumbwheel switches.

⑨ **10KHz THUMBWHEEL SWITCH**

Sets 10KHz digit of the desired operating frequency.

⑩ **100KHz THUMBWHEEL SWITCH**

Sets 100KHz digit of the desired operating frequency.

⑪ **1MHz THUMBWHEEL SWITCH**

Sets 1MHz digit of the desired operating frequency. When you set a digit of a frequency, the set

will work as follows:

Digit	Working frequency band
0	440MHz
1	441MHz
2	442MHz
3	443MHz
4	444MHz
5	445MHz
6	446MHz
7	447MHz
8	448MHz
9	449MHz

⑫ PUSH TO TALK (PTT) SWITCH

For transmission, press this switch and talk into the microphone with normal voice. The internal microphone is of the electret-condenser type and provides good pickup for all levels of voice.

***DUAL-TONE ENCODER PAD**

IC-4AT has a 16 key dual-tone encoder pad on the front panel. The pad can be used for auto-patch, accessing to a closed repeater, and/or other controls.

⑬ **RF POWER SWITCH**

Selects the RF output power HIGH 1.5 Watts (at 8.4V) or LOW 0.15 Watts (at 8.4V). In the LOW position, the current drain is decreased, to prolong the battery life.

⑭ **DUPLEX/SIMPLEX SWITCH**

Selects the operation mode DUPLEX for repeater operation, or SIMPLEX for the same receive/transmit frequency operation.

⑮ **DUPLEX MODE SWITCH**

In the DUPLEX mode, selects the transmitting frequency, 5MHz above or below the receiving frequency according to the desired repeater input frequency.

⑯ **CHARGER CONNECTOR**

Connects to the output plug of the wall charger BC-25U or other power source.

⑰ **BATTERY CHARGE INDICATOR**

Lights during battery charging.

SECTION VI OPERATION

RECEIVING

Make sure the ④ POWER SWITCH is in the OFF position, and before turning ON the power switch, confirm as follows:

1. Make sure the power pack is properly charged and attached to the set.
2. Make sure the supplied flexible antenna is properly set.

When an external antenna is employed, make sure the coaxial line is of the correct impedance (50 ohms) and is neither shorted nor opened, and is firmly connected to the antenna connector.

Set the controls and switches as follows:

- | | |
|---------------------------|-----------------------------|
| ③ SQUELCH CONTROL | Completely counterclockwise |
| ④ VOLUME CONTROL | Completely counterclockwise |
| ⑨ ~ ⑪ THUMBWHEEL SWITCHES | Desired frequency |

(Others may be at any position or setting.)

Turn the ④ VOL control clockwise to click ON and a comfortable audio level.

If only noise can be heard and no signal, turn the ③ SQL control clockwise until the noise from the speaker stops and set it just below this threshold. (When adjusting the SQL setting, if some communication signals can be heard, turn the thumbwheel switch either direction and set it where only noise can be heard.) Your transceiver will now remain silent until an incoming signal is received which opens the squelch. If the squelch is unstable due to the reception of weak or mobile stations, adjust the squelch control further until the proper threshold is obtained.

SECTION VII INSIDE VIEW

MAIN UNIT SIDE

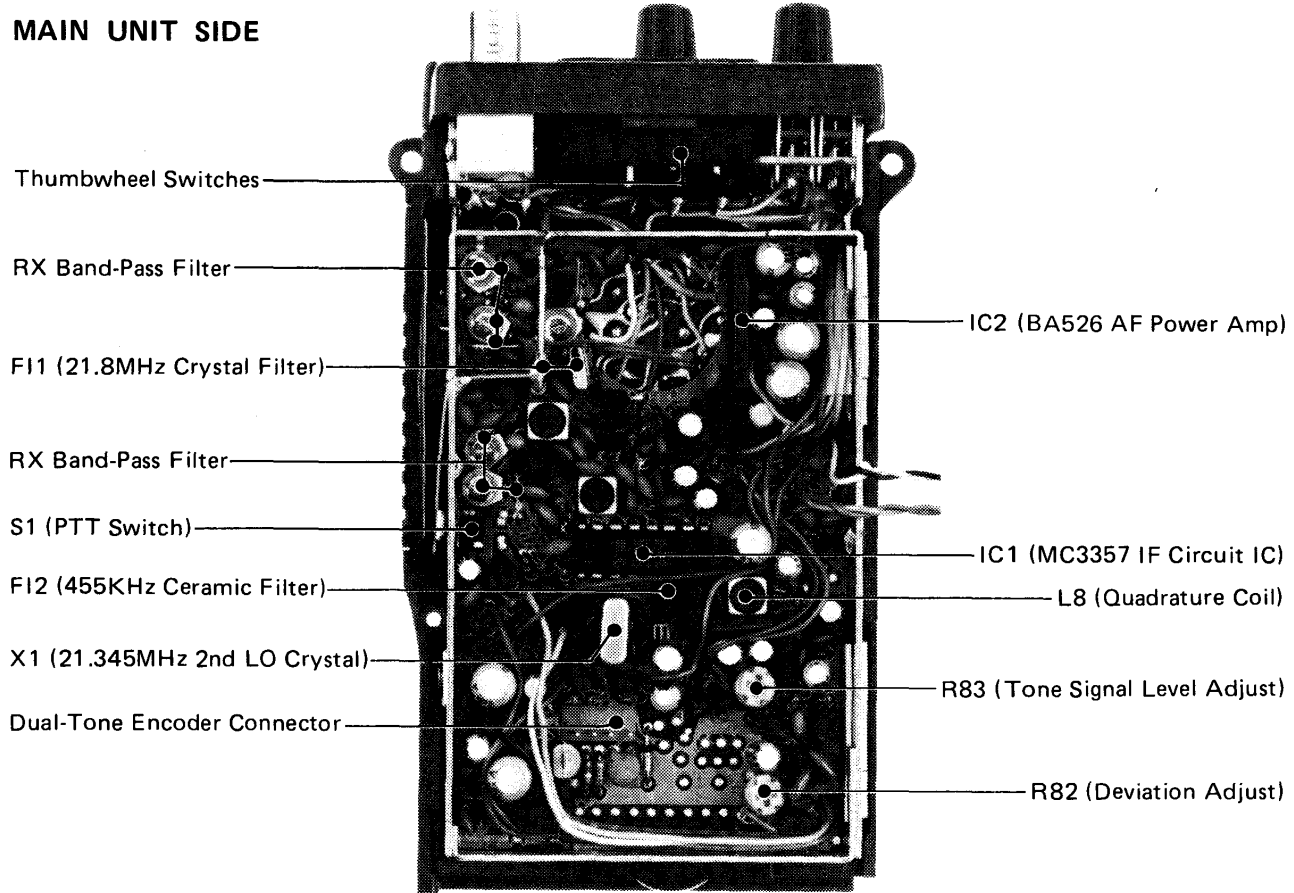

PLL UNIT SIDE

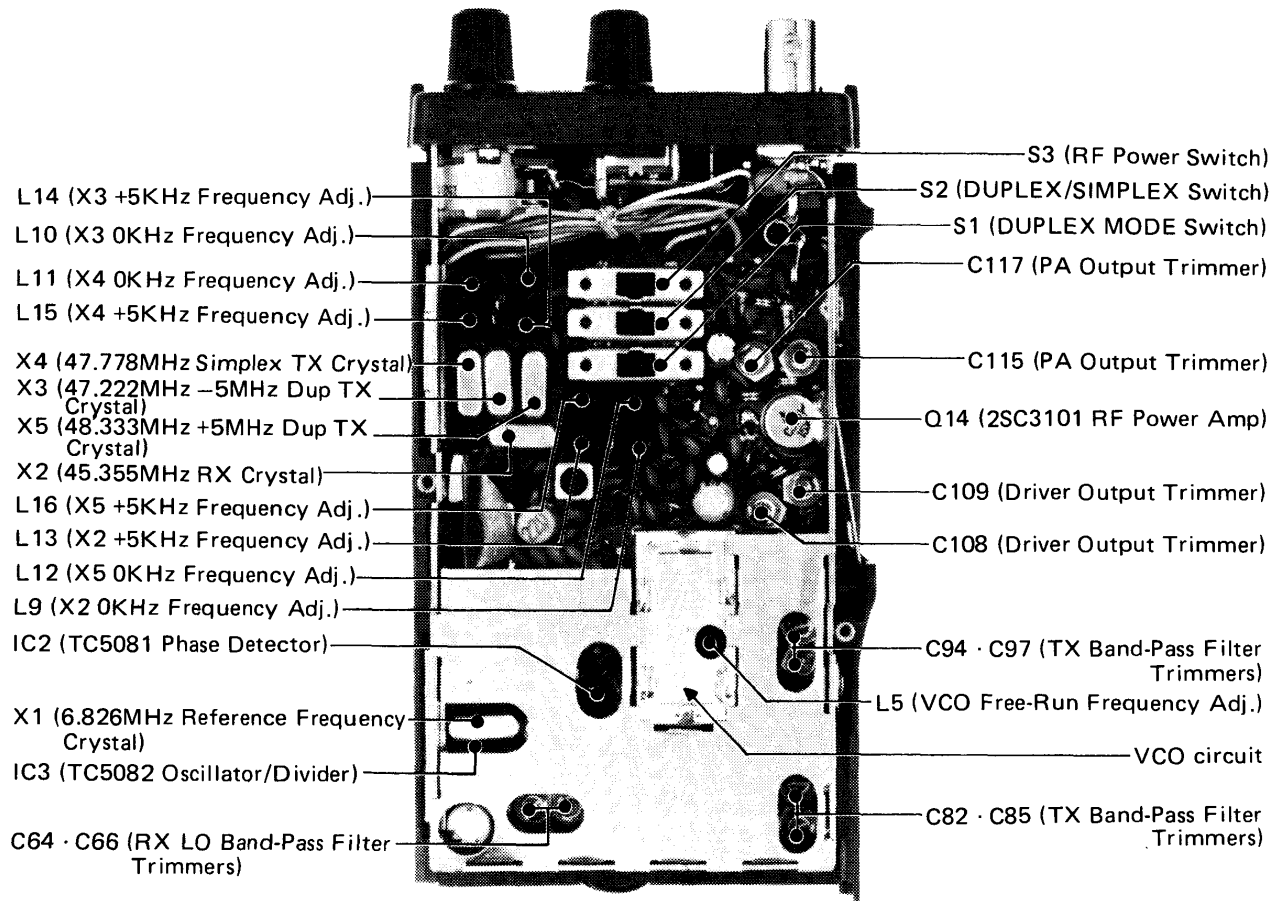

SECTION VIII CIRCUIT DESCRIPTION

RECEIVER CIRCUITS

ANTENNA SWITCHING CIRCUIT

Signals from the antenna connector are fed to the antenna switching circuit through low-pass filter consisting of C1, L1, C4, and L32 and C123 in the PLL board.

The antenna switching circuit employs a quarter wave switching circuit.

In the receive mode, switching diodes, D16 and D17 are turned OFF, and they make isolation against the transmitter circuit and matching circuit, and the incoming signals are fed to the RF amplifier through L31.

RF AMPLIFIER AND FIRST MIXER

The signals from the switching circuit are fed to the cascode amplifier Q1 and Q2.

The amplified signals are fed to the base of the first mixer Q3 through the band-pass filter L2 ~ L5, which reduces interference and intermodulation from out of the band signals.

To the base of Q3, a 418MHz signal is supplied from the PLL circuit to convert the RF signals into 21.8MHz first IF signals.

The first IF signals are taken from the drain of Q3 and fed to the IF circuit.

IF CIRCUIT

The first IF signals from Q3 are fed to the matched pair crystal filter F11, then IF amplifiers Q4 ~ Q6.

The amplified signals are fed to IC1. IC1 is composed of the second local oscillator, second mixer, limiter amplifier, quadrature detector and active filter circuits.

The second local oscillator oscillates 21.345MHz with X1, and is fed to the second mixer with the first IF signals to convert into 455KHz second IF signals. The second IF signals are put out from Pin 3, and fed to external ceramic filter F12 which has excellent selectivity, then fed to IC1 (Pin 5) again to amplify and detect.

The detected AF signals are put out from Pin 9.

AF AND SQUELCH CIRCUITS

The detected AF signals are put 6dB/Octave de-emphasis by integral circuit consisting of R22 and C47, and fed to AF power amplifier IC2 through the VOLUME control R1, to obtain enough power to drive the speaker.

Noise components put out from Pin 9 of IC1 are fed to IC1 (Pin 10) again through the SQUELCH control R2, which controls the squelch threshold level, filtered about 20KHz signal (noise) and put out from Pin 11.

This signal (noise) is rectified by Q14, integrated by R39, R40 and C51, and turns Q15 ON and turns OFF the regulator for AF power amplifier consisting of D4, Q16 and Q17.

This reduces the current drain of the set, in the standby condition. When a signal is received, noise is suppressed by the signal and turns Q15 OFF and the regulator is turned ON and supplies regulated voltage to the AF power amplifier, and incoming signal can be heard from the speaker.

In the transmit mode, a voltage is applied to Q15 and turns it ON, and turns the regulator OFF the same as in the standby condition.

TRANSMITTER CIRCUITS

MIC AMPLIFIER CIRCUIT

Audio signals from the microphone are fed to the limiter amplifier, consisting of Q29 ~ Q32, which has 6dB/Octave response between 300Hz and 3KHz.

The output of the limiter amplifier is similar to rectangular waves and includes harmonics. These harmonics are eliminated by the low-pass filter Q33, which cuts 3KHz or higher. Filtered signals are fed to the VCO in the PLL board to make modulation.

MULTIPLIER AND DRIVE CIRCUITS

The VCO oscillates a third of a transmitting frequency, thus the multiplier Q10 and Q11, multiplies it three times to obtain 440MHz transmitting frequency.

This 440MHz is fed to amplifiers Q12 and Q13 through band-pass filter L22, L23 and L24, L25 to obtain 500 milliwatts pure 440MHz signal. While switching over receive to transmit, Q9 is turned ON by the charged voltage of C73, until the charged voltage has been discharged, and this function cuts

the bias voltage of Q11 ~ Q14.

This prevents transmission of unwanted signals.

POWER AMPLIFIER CIRCUIT

The output signals from Q13 is fed to the power amplifier Q14, and amplified to 1.5 watts.

In the transmit mode, D16 and D17 are turned ON, and D17 makes L31 has high-impedance and D16 feeds the signals to the antenna through the low-pass filter.

PLL CIRCUITS

LOCAL OSCILLATOR CIRCUIT

The crystal oscillator Q7 oscillates 45.35556MHz with X2 for receive, 47.77778MHz with X4 for simplex transmit, 47.22222MHz with X3 for -5MHz and 48.33333MHz with X5 for +5MHz duplex transmit, and the signal at three times this frequency is taken from the collector of Q7, and fed to the mixer of the PLL circuit.

In the receive mode, R+5V is applied to D8 through R23, L9, L13 and R27 and D8 is turned ON and selects X2.

In the simplex transmit mode, T+5V is applied to D10 through R25, L11, L15 and R29 and D10 is turned ON and selects X4.

In the +5MHz duplex transmit mode, T+5V is applied to D11 through R60, L12, L16 and R58 and D11 is turned ON and selects X5.

In the -5MHz duplex transmit mode, T+5V is applied to D9 through R24, L10, L14 and R28 and D9 is turned ON and selects X3.

When the operating frequency has a 5KHz digit, cathodes of D4 ~ D7 are grounded through the 5KHz SHIFT switch, and one of D4 ~ D7 is turned ON according to the operating mode. Thus, one of L9 ~ L12 is shunted accordingly and oscillating frequency is shifted 5KHz (on the operating frequency).

MIXER, LOW-PASS FILTER AND AMPLIFIER CIRCUITS

The output signals from the local oscillator circuit and the VCO signals fed through buffer amplifiers Q3 and Q4 are mixed by the mixer Q5. The output signals are fed to the low-pass filter to filter out only the signals below 7MHz, then fed to Q6 to be amplified to proper drive level (more than 3Vp-p) of the programmable divider IC1.

PROGRAMMABLE DIVIDER CIRCUIT

The input signals at Pin 2 of IC1 are divided by the BCD input signals from the thumbwheel switches at Pin 3 ~ 14.

REFERENCE FREQUENCY GENERATOR CIRCUIT

Reference frequency generator IC3 consists of a crystal oscillator and a highspeed divider. X1 oscillates at 6.8266MHz, which is divided by 2048. The 10/3KHz reference frequency is fed to phase detector IC2. This 10/3KHz reference frequency decides the variation step of the PLL output frequency.

PHASE DETECTOR AND LOOP FILTER CIRCUITS

Digital phase detector, IC2, detects the phase difference of the pulse signals of the 10/3KHz reference frequency and the output signal of the programmable divider, and proportionately puts out pulse signals at Pin 3, which becomes high impedance when the PLL is locked.

Pin 4 is for detecting the lock failures and changes to ground level according to the phase difference of the two pulse signals. When the lock fails, the pulse signal from Pin 4 is intergrated by R10 and C14. When the integrated voltage exceeds the junction voltage of Q9's base in the MAIN board, Q9 is turned ON and then Q8 in the MAIN board is turned ON.

The collector of Q8 is connected to the base of Q7, so the base voltage of Q7 becomes ground level, and Q7 is shut off to prevent transmitting unwanted signals.

The loop filter, consisting of R3 ~ R5, C15 and C16, converts the pulse signal from Pin 3 into a DC voltage and decides the response time of the whole loop.

The output signals are fed to tuning diode D1 of the VCO circuit as the control voltage for the VCO frequency set.

VCO CIRCUIT

The VCO (Voltage-Controlled Oscillator) is a Colpitts circuit using Q2, and oscillates in 140MHz range.

The oscillator frequency is controlled by a DC voltage which is supplied from the loop filter to varactor diode D1.

In the receive mode, R+5V is applied to D2's anode through L3, and D2 is turned ON and shunts C23. Thus the free-run frequency of the VCO is lowered.

In the transmit mode, T+5V is applied to D2's cathode through D3 and L4, D2 is turned OFF, and C23 is inserted in the oscillator circuit in series. Thus the free-run frequency of the VCO is increased. In the same time, the VCO signal is frequency modulated by the audio signals from the microphone which are applied to the gate of Q2 and varies Q2's mutual conductance.

POWER SUPPLY CIRCUIT

The regulated 5V is supplied to the main circuits, so that the set operates under a stable condition with as a lower voltage as possible.

The power supply voltage is fed to the AF power amplifier through the squelch switching circuit and to the 5V regulator consisting of Q20 ~ Q23 and zener diode D5. This regulated 5V is supplied to the PLL circuit.

In the transmit mode, the base of Q26 is grounded through R63, the microphone and the PTT switch,

and Q26 is turned ON. Thus Q7 and Q8 are turned ON and T+5V is actuated, and supplied to the transmitter circuit. At the same time, T+5V turns Q13 ON, and the power supply voltage is applied to the MIC amplifier circuit through Q13.

In the receive mode, Q26 is turned OFF and the bias voltage of Q10 ON. Thus the R+5V is actuated and supplied to the PLL board to switch the local oscillator crystal and the driver transistors of the transmitter circuit.

At the same time, R+5V turns ON the voltage boost circuit consisting of Q12 and Q11, and +6V is supplied to the receiver circuit.

LED INDICATOR CIRCUIT

This LED is lit in the transmit mode, but when the power supply voltage becomes less than 5.5V, it will not be lit.

The power supply voltage is divided by R57 and R58, and applied to the base of Q24. The emitter of Q24 is connected to the regulated 5V source. When the power supply voltage is more than 5.5V, Q24 is turned OFF, Q25 is turned ON and T+5V is applied to the LED through Q25 and R56, and LED is lit.

DUAL-TONE ENCODER CIRCUIT (IC-4AT only)

IC1 is a standard 16 key dual-tone encoder which is compatible with any telephone system. When a key is pushed, IC1 oscillates 3.5795MHz with X1, and its signal is divided depending on the pushed key, and a pair of tones is put out from Pin 16. At this time, Pin 10 of IC1 puts out H-level signal, and this is used to mute the mic amplifier.

SECTION IX TROUBLE-SHOOTING

Your IC-4A/AT has been tested very carefully at the factory before shipping. The chart below has been designed to help you correct any problems which are not equipment malfunctions. If you are not able to locate the problem and/or solve it through use of this chart, please contact your dealer or ICOM distributor for assistance.

Problem	Possible Cause	Solution
1. Power does not come ON when the switch is turned.	Bad connection of the power pack. Reverse polarity of the battery (when using IC-BP4). The battery has been exhausted.	Check the connection of the power pack and correct any problems. Make sure of the polarity of each battery and replace them into the pack. Replace the battery with a new one or recharge it.
2. No sound comes from the speaker.	VOLUME CONTROL knob is completely counterclockwise. The unit is in the transmit mode, by the PTT switch.	Turn the knob clockwise to a suitable level. Put the unit in the receive mode.

Problem	Possible Cause	Solution
<p>2. No sound comes from the speaker. (Continued)</p>	<p>SQUELCH setting is turned too far clockwise.</p> <p>External speaker (or earphone) is in use.</p> <p>The battery has been exhausted.</p>	<p>Turn the SQUELCH CONTROL counterclockwise until noise can be heard and reset it just below the threshold.</p> <p>Check if the external speaker plug is inserted properly or if the external speaker cable is cut.</p> <p>Replace the battery with a new one or recharge it.</p>
<p>3. Sensitivity is low and only strong signals are audible.</p>	<p>Bad connection of the flexible antenna.</p> <p>The antenna feed line is cut or shorted. (When using an external antenna.)</p>	<p>Check the connection of the antenna and correct any problems.</p> <p>Check the feed line and correct any improper condition.</p>
<p>4. No or low RF output.</p>	<p>RF Power switch is set at the Low position.</p> <p>The battery has been exhausted.</p>	<p>Set the RF Power switch to the High position.</p> <p>Replace the battery with a new one or recharge it.</p>

Problem	Possible Cause	Solution
4. No or low RF output. (Continued)	The antenna feed line is cut or shorted. (When using an external antenna.)	Check the antenna feed line and correct any problems.
5. No modulation. (When using external microphone.)	Bad connection of the MIC connector. The MIC cable is cut.	Check the connection of the MIC connector and correct any problems. Repair the disconnected or cut wire.
6. The receive mode functions properly and your signals are transmitted, but you are unable to make contact with another station. (When desiring DUPLEX mode.) (When desiring, SIMPLEX mode.)	The DUPLEX/SIMPLEX Switch is in the SIMP position. Improper input/Output frequency of the repeater. The DUPLEX/SIMPLEX Switch is in the DUP position.	Set the DUPLEX/SIMPLEX Switch in the DUP position, and the DUPLEX MODE switch in +5 or -5 position according to repeater input/output frequencies. Set the DUPLEX/SIMPLEX Switch in the SIMP position.

SECTION X VOLTAGE CHARTS

NOTE: Measuring instrument is a 50K Ω /V multimeter.

MAIN UNIT TRANSISTORS

TR No.	TRANSMIT				RECEIVE				REMARKS
	BASE OR GATE1	GATE2	COLLECTOR OR DRAIN	EMITTER OR SOURCE	BASE OR GATE1	GATE2	COLLECTOR OR DRAIN	EMITTER OR SOURCE	
Q 1	0		0	GND	0.75		2.0	GND	
Q 2	0		0	0	3.0		3.4	2.2	
Q 3	0		0	GND	0.7		4.0	GND	
Q 4	0		0	0	1.7		1.7	1.0	
Q 5	0		0	0	1.0		1.7	0.4	
Q 6	0		0	0	1.7		4.4	2.4	
Q 7	0		4.8	5.0	4.8		0	5.0	
Q 8	0		0	GND	0.3		4.4	GND	
Q 9	0		0	GND	0		0.3	GND	
Q10	4.6		0	5.0	4.2		5.0	5.0	
Q11	8.4		0	9.0	8.4		6.0	9.0	
Q12	0		8.0	0	5.0		8.0	4.0	
Q13	5.0		8.4	4.0	0		9.0	2.8	
Q14	0		0	0	4.0		0/1.7	3.8/3.0	SQL OFF/ON
Q15	0		0	GND	0/0.6		8.0/0	GND	SQL OFF/ON
Q16	0		8.4	0	8.0/0		8.4	7.6/0	SQL OFF/ON

TR No.	TRANSMIT				RECEIVE				REMARKS
	BASE OR GATE1	GATE2	COLLECTOR OR DRAIN	EMITTER OR SOURCE	BASE OR GATE1	GATE2	COLLECTOR OR DRAIN	EMITTER OR SOURCE	
Q17	8.4		0	9.0	8.4		7.6/0	9.0	SQL OFF/ON
Q18	5.0		8.4	4.0	0		8.4	0	
Q19	8.4		6.0	9.0	8.4		0	9.0	
Q20	0.6		9.0	1.3	0.5		9.0	1.3	
Q21	8.2		5.0	9.0	8.4		5.0	9.0	
Q22	0.6		8.1	GND	0.5		8.3	GND	
Q23	0.6		0.6	GND	0.6		0.5	GND	
Q24	5.7		3.4	5.0	5.8		0	5.0	
Q25	3.4		4.0	4.0	0		0	0	
Q26	4.8		3.8	5.0	3.7		1.3	5.0	
Q27	0		3.6	GND	0.6		5.0	GND	
Q28	0		0.6	GND	0		0	GND	
Q29	1.5		4.0	2.0	0		0	0	
Q30	2.1		3.4	2.0	0		0	0	
Q31	3.4		1.8	4.0	0		0	0	
Q32	0.6		0.7	GND	0		0	GND	
Q33	0.7		4.0	1.9	0		0	0	
Q34	—		—	—	—		—	—	Deleted
Q35	0		0	GND	0.7		0	GND	

PLL UNIT TRANSISTORS

TR No.	TRANSMIT				RECEIVE				REMARKS
	BASE OR GATE1	GATE2	COLLECTOR OR DRAIN	EMITTER OR SOURCE	BASE OR GATE1	GATE2	COLLECTOR OR DRAIN	EMITTER OR SOURCE	
Q 1	—		—	—	—		—	—	Deleted
Q 2	0		4.0	0.6	0		4.0	0	
Q 3	0.7		0.7	GND	0.7		0.7	GND	
Q 4	1.8		2.8	0.7	1.8		2.8	0.7	
Q 5	0.7		0.75	GND	0.7		0.75	GND	
Q 6	1.4		3.2	1.0	1.4		3.2	1.0	
Q 7	1.6		5.0	1.0	1.6		5.0	1.0	
Q 8	0		0	1.2	1.7		5.0	1.3	
Q 9	0		1.3	GND	0.6		0	GND	
Q10	0.5		1.3	GND	0.4		0.8	GND	
Q11	1.3		4.0	0.5	0		0	0	
Q12	1.2		8.5	0.5	0		9.0	0	
Q13	0.5/0.7		9.0	0.3/1.5	0		9.0	0	Power Hi/Low
Q14	0.3/0.5		9.0	GND	0		9.0	GND	Power Hi/Low

IN TRANSMIT MODE

UNIT	IC No.	PIN No.																	REMARKS	
		1	2	3	4	5	6	7	8	9	10	11	12	13	14	15	16	17		18
MAIN	IC1	0	0	0	0	0	0	0	0	0	0	0	GND	0	0	GND	0			
MAIN	IC2	0	0	0	0	GND	0	0	0	0										
PLL	IC1	5.0	2.0	0	0	0	0	0	0	0	0	0	0	0	0	5.0	0	0	GND	f = 440MHz
PLL	IC2	5.0	0	1.2	5.0	5.0	0	0	2.4	GND										
PLL	IC3	1.0	2.0	2.4	2.4	5.0	2.4	2.4	2.4	GND										
DUAL TONE	IC1	6.1	5.7	6.1	6.1	6.1	GND	0	6.1	6.1	0	0	0	0	0	4.4	0			IC-4AT only

IN RECEIVE MODE

UNIT	IC No.	PIN No.																	REMARKS	
		1	2	3	4	5	6	7	8	9	10	11	12	13	14	15	16	17		18
MAIN	IC1	5.2	5.2	5.4	5.8	0.9	0.9	1.1	5.8	2.9	1.7	2.2	GND	5.1	0	GND	2.0			
MAIN	IC2	6.1	4.0	7.6	3.4	GND	3.2	3.2	3.2	3.2										
PLL	IC1	5.0	1.6	0	0	0	0	0	0	0	0	0	0	0	0	5.0	0	0	GND	f = 440MHz
PLL	IC2	5.0	0	1.2	5.0	5.0	0	0	2.4	GND										
PLL	IC3	1.0	2.0	2.4	2.4	5.0	2.4	2.4	2.4	GND										
DUAL TONE	IC1	0	0	0	0	0	GND	0	0	0	0	0	0	0	0	0	0			IC-4AT only

SECTION XI BLOCK DIAGRAM

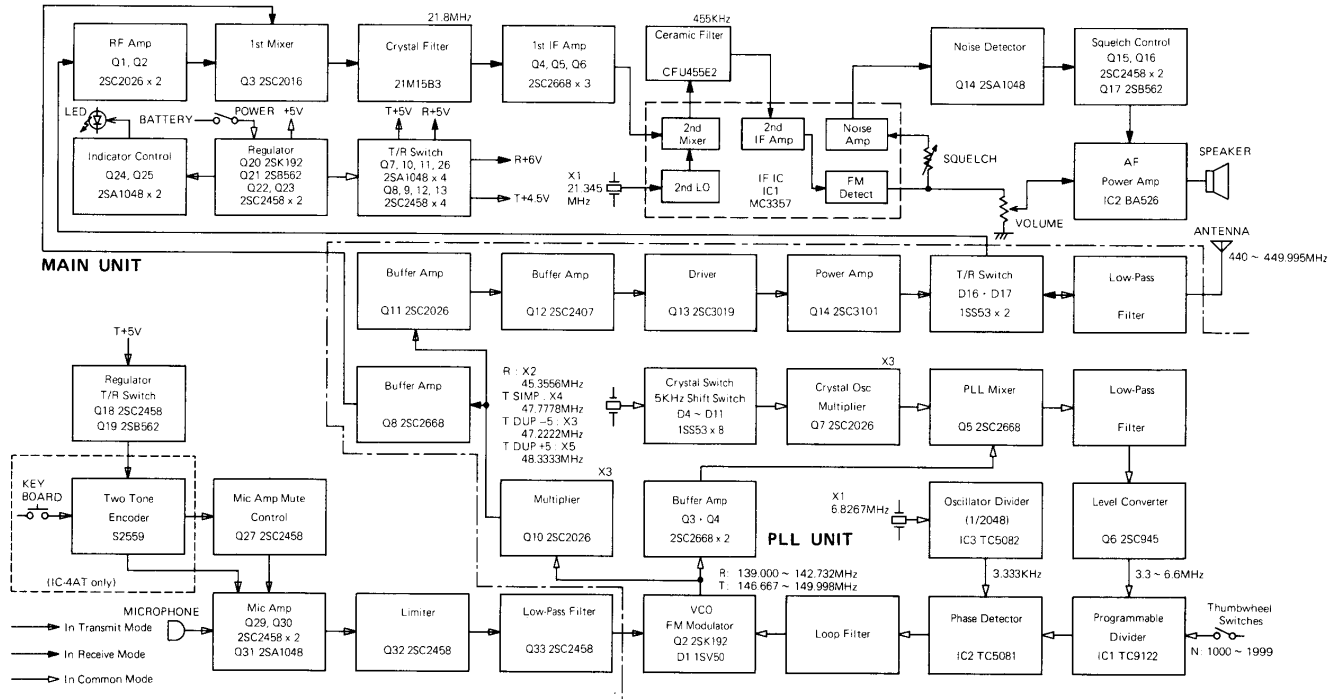

SECTION XII OPTIONS

We have prepared a variety of options for the transceiver IC-4A/AT in order to expand its use.

1. BC-30 Nickel-Cadmium Battery Charger

A convenient set-in type charger for Nickel-Cadmium power packs. Two charging rates provided; high speed and regular rate. The charger is compatible with any type of Nickel-Cadmium power packs.

2. IC-BP2 Nickel-Cadmium Power Pack

This power pack has six AA type 400mAH Nickel-Cadmium batteries and provides 1W output power for the IC-4A/AT with longer attendant use capability. Recharge time, when using the BC-30 is 1-1/2 hours.

3. IC-BP4 Battery Case

This case will accept dry batteries, zinc or alkaline, for 1.5W output, or Nickel-Cadmium for 1W output power. It holds six cells. When Nickel-Cadmium batteries are installed the BC-30 can be used to recharge the batteries.

4. IC-BP5 Nickel-Cadmium Power Pack

This power pack has nine AA type 400mAH Nickel-Cadmium batteries and provides 2.3W output power, plus longer operating capability. It can be recharged by the BC-30 in 1-1/2 hours.



5. IC-CP1 Cigarette Lighter Recharger for IC-BP3

A handy way to recharge the Nickel-Cadmium packs while mobile - plugs in the cigarette lighter.

6. IC-HM9 Speaker/Microphone

A handy speaker and microphone in one unit. Clips on the clothing and operates as both speaker and microphone when plugged in the unit.

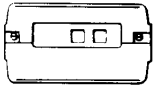
SPECIFICATIONS

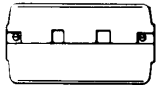
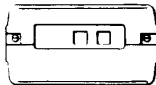
	IC-BP2	IC-BP3	IC-BP4	IC-BP4	IC-BP5
Cells [Capacity]	N-425A R (X 6) [400mAH]	N-250A A (X 7) [250mAH]	AA Size Alkaline (X 6)	AA Size Nickel- Cadmium (X 6)	N-425A R (X 9) [400mAH]
Voltage	7.2V	8.4V	9.0V	7.2V	10.8V
RF Output	1.0W	1.5W	1.5W	1.0W	2.3W
Charging	Rapid	Normal		Normal	Rapid
Charging Time	1 ~ 1.5H	15H		15H	1 ~ 1.5H
Suitable Charger	BC-30	BC-30 BC-25U IC-CP1		BC-30	BC-30
Charging Current	600mA	25mA		45mA	600mA
Ambient Temperature	+10°~+40°C	0°~+45°C		0°~+45°C	+10°~+40°C
Overcharge Protect	○	X		X	○
Current Selector					
Height	39m/m	39m/m	49m/m	49m/m	60m/m
Battery Replace	X	X	○	○	X



ICOM INCORPORATED

1-6-19, KAMI KURATSUKURI, HIRANO-KU
OSAKA JAPAN

A-0367
Printed in Japan